

## Bandfit施工可否の範囲

施工する継手を中心から下表のX,Y,Z,Lの範囲内に障害物(壁、他の配管、支持金具、継手など)がある場合はBandfitが取り付け出来ません。

①エルボ

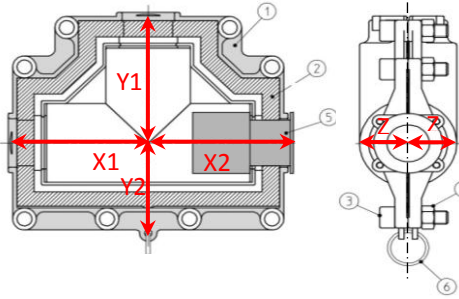

単位(mm)

呼び径	X1	X2	Y1	Y2	Z
20	84.2	87.7	84.2	59.5	22.9
25	89.7	93.2	89.7	67.6	26.3
32	97.3	100.8	97.3	73.4	32
40	101.8	105.3	101.8	77.9	36.6
50	105.5	109	105.5	81.5	40.1

④径違いソケット

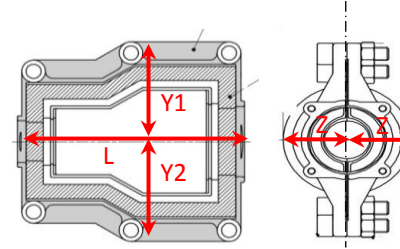

単位(mm)

呼び径	Y1	Y2	Z	L
50X25	73	73	40.1	157.4

②ソケット

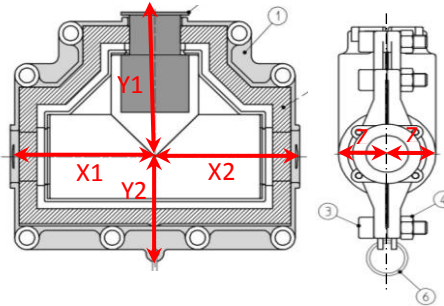

単位(mm)

呼び径	X1	X2	Y1	Y2	Z
20	84.2	84.2	87.7	59.5	22.9
25	89.7	89.7	93.2	67.6	26.3
32	97.3	97.3	100.8	73.4	32
40	101.8	101.8	105.3	77.9	36.6
50	105.5	105.5	109	81.5	40.1

⑤径違いソケット

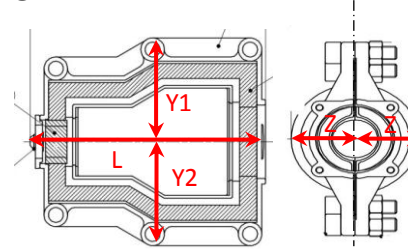

単位(mm)

呼び径	Y1	Y2	Z	L
50X20	73	73	40.1	164.2

③径違いソケット

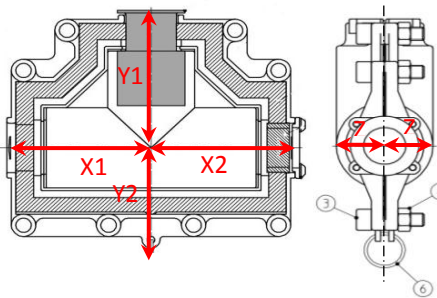

単位(mm)

呼び径	X1	X2	Y1	Y2	Z
25X20	89.7	96.5	93.2	67.6	26.3
30X20	97.3	104.1	100.8	73.4	32
30X25	97.3	104.1	100.8	73.4	32
40X30	101.8	108.6	105.3	77.9	36.6
50X30	105.5	112.8	109	81.5	40.1
50X40	105.5	112.8	109	81.5	40.1

⑥径違いソケット

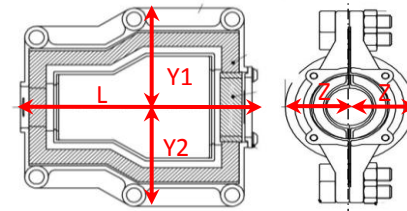

単位(mm)

呼び径	Y1	Y2	Z	L
40X25	73	73	40.1	164.2

⑦径違いソケット

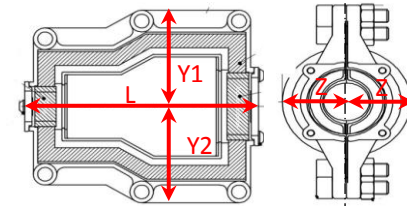

単位(mm)

呼び径	Y1	Y2	Z	L
40X20	73	73	40.1	170.9

⑧チーズ、径違いチーズ

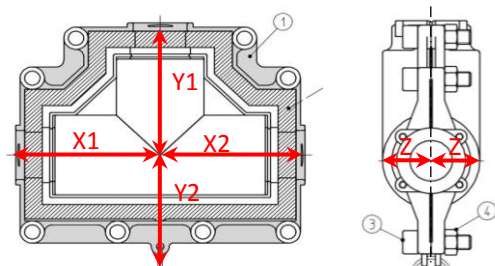

単位(mm)

呼び径	X1	X2	Y1	Y2	Z
20	84.2	84.2	84.2	59.5	22.9
25	89.7	89.7	89.7	67.6	26.3
30	97.3	97.3	97.3	73.4	32
40	101.8	101.8	101.8	77.9	36.6
40x25	92	92	99.5	77.9	36.6
50	105.5	105.5	105.5	81.5	40.1
50x25	92.8	92.8	103.2	81.5	40.1

⑨径違いチーズ

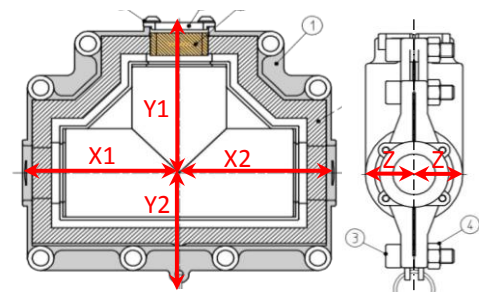

単位(mm)

呼び径	X1	X2	Y1	Y2	Z
25x20	89.7	89.7	96.5	67.6	26.3
30x20	97.3	97.3	104.1	73.4	32
30x25	97.3	97.3	104.1	73.4	32
40x20	92	92	106.3	77.9	36.6
40x30	101.8	101.8	106.3	77.9	36.6
50x20	92.8	92.8	110	81.5	40.1
50x30	105.5	105.5	112.3	81.5	40.1
50x40	105.5	105.5	112.3	81.5	40.1